



RSW28

Rider Vacuum Sweeper

Operating & Maintenance Manual



Thank you for purchasing a Pacific Floorcare product. Carefully inspect all components for freight damage. If such damage is discovered, file a "CONCEALED DAMAGE REPORT" immediately with the delivering carrier.

Read this manual carefully and keep it near the machine, protected from liquids and other damaging substances. Failure to follow the instructions may result in injury or damage to equipment and property.

The contents of this manual are based on the latest product information available at the time of publication. Pacific Floorcare reserves the right to make changes or improvements without being obliged to apply changes to the machines previously sold.

New manuals can be downloaded from: <https://pacificfloorcare.com/parts-manuals/>



Rev A 121820

TABLE OF CONTENTS

	Page
1. GENERAL INFORMATION	
1.1. Symbols	3
1.2. Notes	3
1.3. Manual references	3
1.4. Warranty	3
2. FEATURES AND SPECIFICATIONS	
2.1. Identification	6
2.2. Description and components	6
2.3. Specifications	7
3. SAFETY	
3.1. Correct use	8
3.2. Misuse	8
3.3. OEM parts & equipment	8
3.4. Operator qualification	9
3.5. Protection and alarm systems	9
3.6. Safety devices	10
3.7. Safety diagnostic alerts	10
3.8. Dangers	12
3.9. Safety Signals	13
4. INSTRUCTIONS FOR STARTING AND USE	
4.1. Transport and handling	15
4.2. Storage	16
4.3. Unpacking the machine	16
4.4. Handling an unpacked machine	16
4.5. Installation	17
4.5.1 Battery Installation	17
4.6. Control devices	18
4.6.1. Control panel	19
4.7. Functions	19
4.7.1. Levers & Pedals	20
4.7.2. Main Brush Replacement	21
4.7.3. Side Brush Replacement	21
4.7.4. Waste hopper	22
4.7.5. Vacuum motor maintenance	22
4.7.6. Filter shaker motor maintenance	22
5. MAINTENANCE	
5.1. Maintenance table	23
5.2. Battery maintenance	23
5.2.1. Battery water levels	24
5.2.2. Filling batteries	24
5.2.3. Charging	24
5.2.4. Inactive batteries	24
5.2.5. Disposal	24
5.3. Checking the electrical system	25
5.4. Testing schedule	25
5.5. Maintenance log	26

1. GENERAL INFORMATION

1.1. SYMBOLS

	<i>This symbol is used to alert the operator on procedures or precautions that must be followed to avoid injury or damage</i>
	<i>This symbol is used to inform the operator on general information</i>

1.2. NOTES

	<p><i>All rights reserved to copy, totally or in part, and transmission to third parties by mechanical, electronic or whatever means, without the expressed permission of the manufacturer.</i></p> <p><i>This manual was delivered with the RSW28, of which it constitutes an integral part. This manual shall remain with the equipment in the event of an ownership transfer. Please keep in a safe place. Purchaser is responsible to forward this manual to any responsible parties.</i></p> <p><i>Pacific Floorcare shall be held harmless for any kind of possible damages caused by persons and/or things due to non-observance of instructions in this manual.</i></p> <p><i>Pacific Floorcare reserves the right to make equipment changes or updates without notice. Therefore, data and information contained in this manual could have changes and/or updated notes.</i></p>
---	---

1.3. MANUAL REFERENCES

This manual ensures easy and safe use of the machine, as recommended by European Directives about product security.

It is recommended all authorized operators read this manual in its entirety before operation. This manual must also be used as procedural reminders or for the training of a new operator.

Pictures or drawings are used for reference and may differ from the physical machine.

Special symbols, **bold type** and/or *italicized text* are used to gain the attention of the reader on important information, particularly for safety.

List of revised pages can be found to the end of this manual.

1.4. WARRANTY

Terms and conditions of warranty are stated below

OBJECT OF WARRANTY

The RSW28 Sweeper has been conceived and built for long-term, trouble-free use. In the event a problem should arise during the warranty period, Pacific Floorcare will, at its discretion, repair and/or replace defective parts which have shown premature breakage or wear and tear caused by defective materials or workmanship.

Warranty does not cover the following:

- Failure to following the procedures and operation instructions included in this manual.
- Equipment modifications without the approved written consent of Pacific Floorcare.
- Non-use of genuine wear parts.
- Repairs made by unauthorized personnel.
- Improper or missing maintenance.
- Natural calamities or Acts of God.

WARRANTY TERMS

Labor: Only a Pacific Floorcare Authorized Service Provider with a written factory service agreement may evaluate and/or repair Pacific Floorcare equipment. Labor for any warranty repair is authorized for one (1) year following the date of sale to the end-user. Once an Authorized Service Provider has been identified, it is the end user's responsibility to contract repairs. The authorized service provider will file any verified warranty claims with Pacific Floorcare in accordance with the written factory agreement.

Parts: Parts determined to be defective are covered for three (3) years following the date of sale to the end-user. Pacific Floorcare reserves the right to inspect defective parts prior to crediting any warranty claims.

AGM Maintenance Free Batteries: In addition to the terms above, any original equipment Pacific Floorcare Battery which becomes unserviceable under normal use within two (2) years (730 days) from date of sale to the original user will be repaired or replaced with one of equal specification with no charge to the user.

Disclaimer: This warranty limits Pacific Floorcare's liability to the repair of the equipment and/or replacement of the defective parts and does not include incidental or consequential damages arising from the use of a Pacific Floorcare machine whether defective or not. This warranty is in lieu of all other expressed or implied warranties and is extended to the original purchaser/user only.

Return Material Authorization (RMA): Warranty credit or replacement of returned parts is subject to an incoming inspection of those items.

EXCLUSIONS

Warranty does not cover normal wear parts and materials (brushes, squeegee blades, etc...).

APPLICATION

In order to establish potential failure cause(s) and so the warranty may be applied, it may be necessary for the defective components need to be sent to Pacific Floorcare. Repairs, replacement or substitutions under the provisions of the warranty will be made at Pacific Floorcare's discretion.

AUTHORIZATION

Authorization must be granted by Pacific Floorcare's technical service department either in writing or by phone. To properly start a warranty claim the following information must be provided:

- Machine model as shown on the equipment label (reference section 2.1)
- Machine serial number as shown on equipment label (reference section 2.1)
- Detailed description of issue and relevant information on how the issue happened or was discovered
- Part number and position of possible defective component as referenced from spare parts list

GOODS TO BE RETURNED – RETURN MATERIAL AUTHORIZATION (RMA)

In the case of goods to be returned for warranty replacement, it is necessary to have written acceptance from the Pacific Floorcare technical service department. A Return Material Authorization (RMA) number will be issued.

All defective parts must be carefully packed in order to avoid further damages during transport.

Goods must be shipped with the following information:

- **Serial number of the equipment**
- **Part number of the defective part (if known)**
- **Detailed description of the defect and of the conditions where it happened**
- **RMA clearly written / applied to the outside of the shipping box**

In case of defective electronic goods, please return them separately from other materials, in order to help us properly handle dangerous waste goods and recycle.



Returned components recognized under warranty become the property of Pacific Floorcare.



Missing information may result in denial of warranty.

2. FEATURES AND SPECIFICATIONS

2.1. IDENTIFICATION

The silver label placed on the steering column will identify the machine model, serial number and date of manufacture.

Pacific Floorcare		MADE		CE
Muskegon (MI), USA		IN ITALY		
Mod	RSW28	S.N		2
V		Hz		0
Kg		A	W	2
				0



Figure 2.1



Do not remove or tamper with the identification label. It should remain legible and affixed on the machine.

2.2. DESCRIPTION AND COMPONENTS

The RSW28 rider vacuum sweeper is designed for the care of flat surfaces through the process of brushing and collection of dirt and debris into an onboard waste hopper. The system of power is supplied by a series of batteries, which power all the motors and the electrical controls.

By means of a rotating brush set in the front of the machine, dirt and debris is put to the middle of the machine. The main brush then moves dirt and debris into the waste hopper. This machine must be used on dry surfaces.

From the seated position the operator can control the function of the machine from the steering column control panel. There is also a battery level indicator on the control panel.

Control panel functions:

- Select forward or reverse
- Throttle
- Horn
- On / off key switch
- Shake the filter
- Brush controls
- Waste recovery

Each machine is inspected during the manufacturing process and the final quality check is done before shipping the machine.

2.3. SPECIFICATIONS

	RSW28
SWEEPING WIDTH	28.7 in / 728 mm
CLEANING CAPACITY UP TO	39,180 ft ² /h / 3640 m ² /h
RUN TIME	4 hrs
WASTE HOPPER CAPACITY	2,448 cu in. - 10.6 gal / 40 ltr
FILTERING SURFACE	32.3 ft ² / 3 m ²
GENERAL TECHNICAL DATA	
MECHANICAL DRIVE	REAR
MECHANICAL DRIVE (type)	DRIVING WHEEL
FORWARD SPEED	0-3.1 mph / 0-5 km/h
MAX SLOPE	8 %
NOISE LEVEL	65 dB
TURNING RADIUS	68.9 in / 1750 mm
ELECTRIC SYSTEM	
POWER	24 V
CENTRAL MOTOR BRUSH	1 x 650W/24V
LATERAL MOTOR BRUSH	1 x 60W/24V
TRACTION MOTOR	200W/24V
VOLTAGE	2 x 12V-157A/h
DIMENSIONS AND WEIGHT	
LENGTH	40.9 in / 1040 mm
WIDTH	27.2 in / 690 mm
HEIGHT	47.2 in / 1200 mm
CENTRAL BRUSHES	10.2 x 23.2 in / 260 x 590 mm
LATERAL BRUSHES	7.9 in / 200 mm
WEIGHT (without batteries)	242.5 lbs / 110 Kg
WEIGHT (with batteries)	357.1 lbs / 162 Kg



Specifications may be changed without notice

MEASUREMENT UNITS CONVERSION			
Length	1 inch = 1" = 25,4 mm	Power	1 kW = 1,36 CV = 1,34 BHP
Temperature	T (K) = t (°C) + 273 / t (°F) = 1,8 t (°C) + 32	Pressure	1 bar = 100 kPa = 14,5 psi

3. SAFETY

3.1. CORRECT USE

	<p><i>The RSW28 has an intended use to clean flat floors or floors with maximum slope of 8%.</i></p>
--	--

3.2. MISUSE



	<p><i>Read all machine labels and do not cover, alter or remove labels.</i></p>
---	---

Pacific Floorcare will not be held responsible for improper use of the machine.

3.3. OEM PARTS & EQUIPMENT

In order for the machine to function properly, only use original equipment replacement parts. Please contact the Pacific Floorcare Technical Service department for assistance.

3.4. OPERATOR QUALIFICATION

Operator qualifications for different machine uses

OPERATION TYPE	OPERATOR QUALIFICATION
Use / Inspection	Properly trained operator
Installation / removal	Authorized technician
Mechanical parts maintenance	Authorized technician
Electrical parts maintenance	Authorized technician
Routine maintenance	Properly trained operator
Dismantling and disposal	Authorized technician

We recommend properly training operators before machine use. We recommend operators read and understand information and procedures outlined within this manual.

Pacific Floorcare is not responsible for any possible damage to people and/or things caused by the non-observance of the instructions dealt within this manual.

3.4. PROTECTION AND ALARM SYSTEMS



- It is forbidden to tamper with protection and alarm systems. They must be in proper working order at all times. We recommend verifying periodically they are functioning properly.*

Central brush protection

Pacific Floorcare RSW28 is equipped with a central nylon brush which rotates when the machine is working. The central brush is protected on both sides by a stainless-steel panel and two cases which avoid contact with dangerous components. These protection devices must remain properly installed for the safety of the operator and proper machine operation



3.5. SAFETY DEVICES

The machine is equipped with the following safety devices.

- **Battery Plug** (picture 3.6), the same plug used for the battery charger. In case of emergency, this plug must be disconnected by lifting up on the plug's handle.

The operator must be trained about machine safety. Do not restore this safety system before the problem has been corrected. If it is necessary, ask for a technician's help.

Disconnect in case of emergency

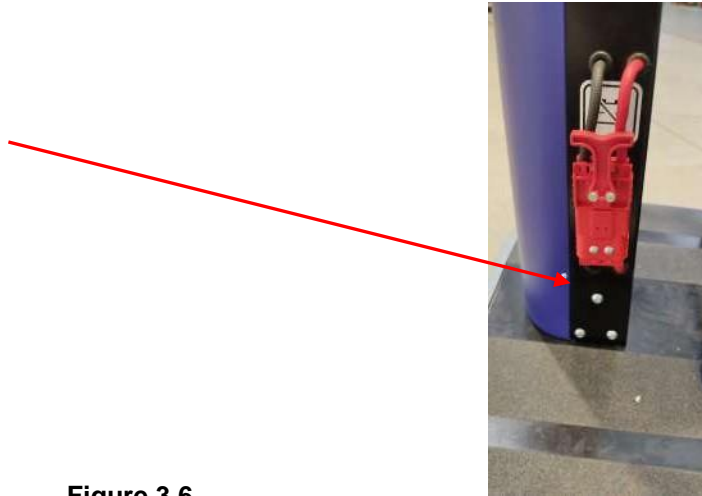

Figure 3.6

3.6. SAFETY DIAGNOSTIC ALERTS

The RSW28 Rider Vacuum Sweeper is equipped with a system that flashes error codes on the battery charge indicator. The flash series will give the operator an indication of the error and the table below presents a solution to correct the error.

No. of flashes	Description	Solution
1	The direction was set to forward prior to turning the key switch to the on position.	Release the forward setting to stop this signal. If this does not stop it; it may be necessary to turn the machine off and back on.
2	Battery charge levels are too low or improper battery installed.	Verify the battery charge level. If it is a low reading, recharge the batteries. Check that all electric connections are secure. If the problem is not solved it might be necessary to replace the batteries.

3	Not used.	
4	Motor not connected or false contact on the motor circuit.	Check the connections of the motor, its functionality and integrity. Check the motor brushes and replace if necessary.
5	Fault inside the controller.	Check the regulator.
6	Faulty potentiometer.	Check the wiring of the potentiometer and the integrity of it.
7	Temperature of the power circuit is too high.	Wait for the high temperatures to subside.
8	Motor is already running or machine is in motion when trying to start.	Stop the vehicle first and then repeat.
9	Anomaly to the microcontroller software or hardware problem.	Try to turn off the vehicle. If the error still appears, check the controller.

3.7. DANGERS

To reduce the risk associated with potential dangers, please adhere to the following:

Dangers and pinch points exist when performing the following maintenance:

- **When replacing the brushes**
- **When performing battery maintenance**

All maintenance operations must be performed with the machine turned off.

PACIFIC FLOORCARE realizes – starting from the design of the machine - all the dangers that can occur while the machine is operating in order to prevent or at least low the operator's accidents.

IMPORTANT: The machine must off and the key removed from the key switch.

Tipping Danger

Tipping danger may happen:

- **During the normal use when the machine passes the gradient limits specified in this manual or when the machine is used on irregular surfaces.**





Do not operate the machine on sloping surfaces higher than 8% or surfaces with holes or depressions which might compromise the stability of the machine.



Pacific Floorcare shall not be held liable for accidents to persons or things when using the machine on surfaces that can compromise stability. The operator has to follow recommendations about environmental conditions in the areas where the work is to be performed.

3.8. SAFETY SIGNALS

Safety signals include:

DANGERS		Signals are triangular shaped with black colored in yellow field pictograms
PROHIBITED		Signals are circular shaped with black colored in white field red-crossed pictograms

	What is it?	NEVER remove covers in which components are still moving.
	What to do	In phase of installation/maintenance the machine must be turned off and the ignition key removed from the control board. Do not operate the machine with damaged, altered, missing or removed guards and covers.





	What is it?	This signal shows crushing or pinch dangers due to moving parts of the machine.
	What to do	In phase of installation/maintenance the machine must be turned off and the ignition key removed from the control board.

	ALWAYS adhere to these alerts.
---	---------------------------------------

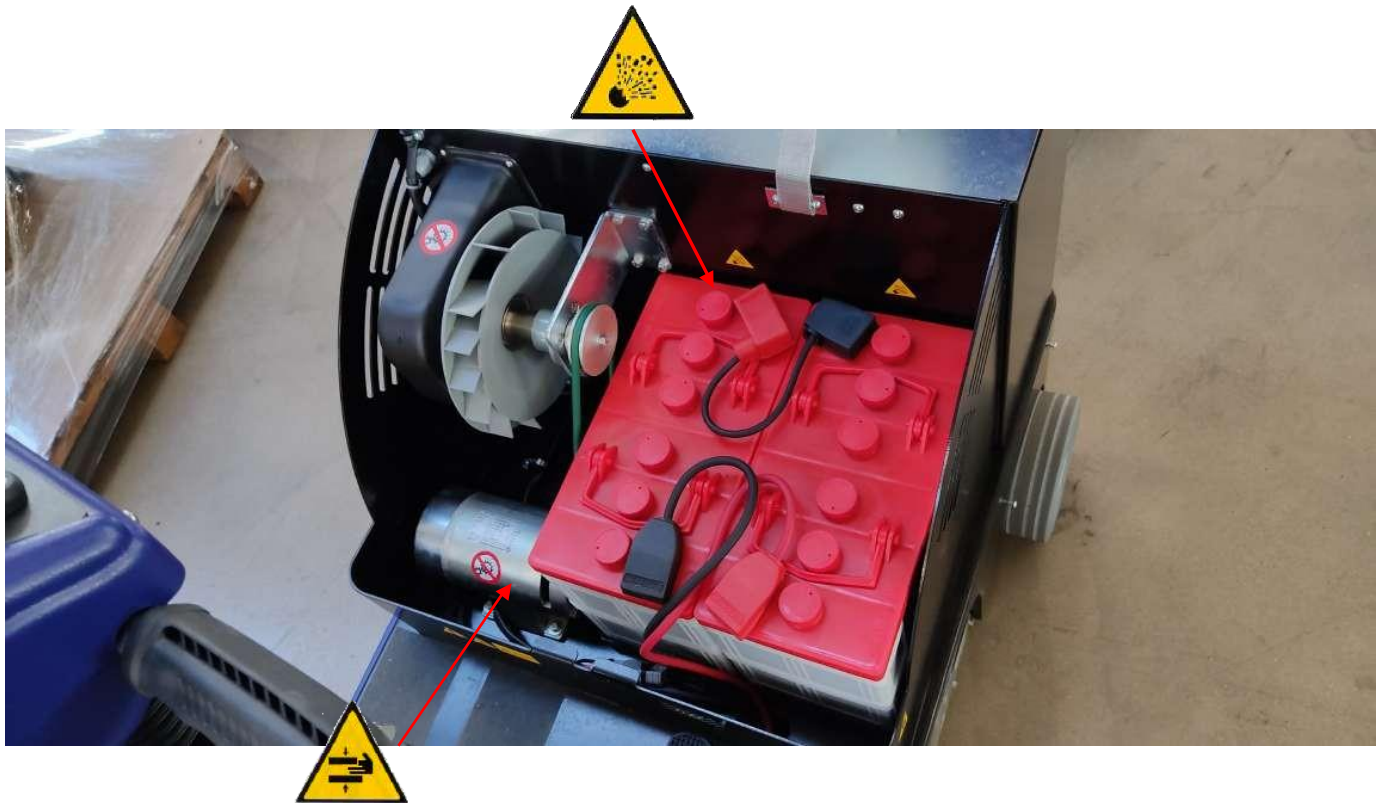
	What is it?	Explosion danger
	What to do	Only charge batteries in a well ventilated area and keep away from heat and corrosive substances.



	What is it?	Risk of crushing or pinching due to overturning of the recovery tank.
	What to do	Take extreme caution while working in the limited area of the battery compartment.

	Replace safety labels on the machine if they are damaged. Do not remove or tamper with labeling or safety systems.
---	---

4. INSTRUCTIONS FOR STARTING AND USE

4.1. TRANSPORT AND HANDLING

The RSW28 is shipped in specially designed packaging to ensure safe delivery. Figure 4.1 shows the center position indicated with a black arrow. Forklift tines must be placed in such a way as the black arrow is at the center of them. Use caution when moving and avoid stacking. If agreed upon to ship without packaging, please secure machine with straps and blocking. Do not transport in a manner where adverse weather or surroundings could damage the machine or packaging.



Carefully inspect all components for freight damage. If such damage is discovered, file a "CONCEALED DAMAGE REPORT" immediately with the delivering carrier.

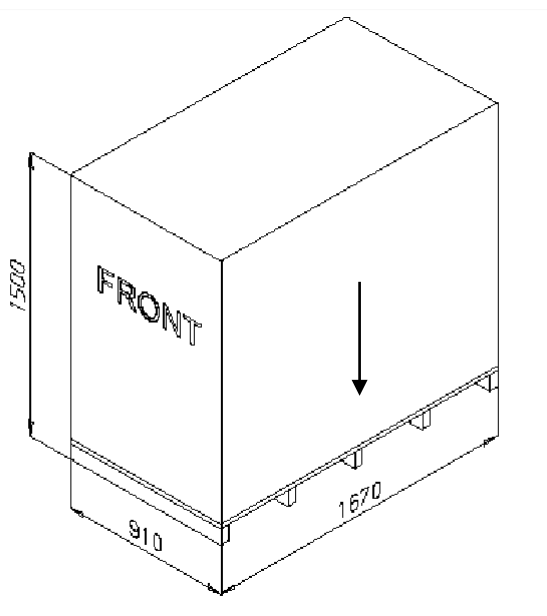

Figure 4.1

The machine must be handled with proper devices as stated in the scheme below.

Make always sure that the black arrow on the package is in the middle of the elevator forks or the straps. Anchorage and/or strapping points are set up in order to keep the machine on balance during the transport.

PACKAGE	HANDLING EQUIPMENT	PIC.
Carton box or plywood box on a pallet	Fork elevator	Nr. 4.2



When handling the machine, ensure the load is balanced and secure. Avoid handling on uneven surfaces.



Machine dimensions and mass are explained in section 2.3. We strongly recommend authorized personnel for handling operations.

LOADING SYSTEM

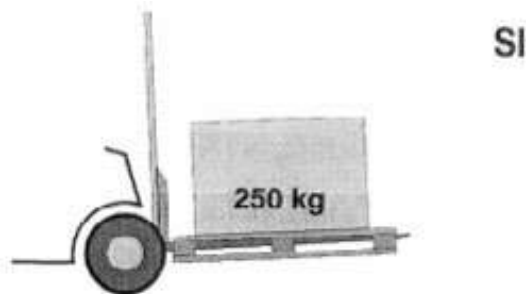

Figure 4.2

4.2. STORAGE

In case the machine is not immediately installed, it has to be kept in a dry and secure. Humidity must be lesser than 80 % and storage temperature between 37° F to 113° F ($3^{\circ} \text{C} \leq t \leq + 45^{\circ} \text{C}$).

4.3. UNPACKING THE MACHINE

- Carefully cut off the banding
- Take away on the base of the carton the clips that keep it secure to the pallet.
- Where plywood is, take away the clips on both sides and at the base of each panel.
- Cut off the clips that secure the machine.
- Place the machine at ground level.

4.4 HANDLING AN UNPACKED MACHINE

- Check the machine and install the batteries if not installed.
- To transport the machine, remove the battery cables, the brushes and the squeegee. If available, we recommending using the original packaging to transport.

4.5. INSTALLATION



The installation must be done by authorized personnel.

4.5.1 BATTERY INSTALLATION

Please follow the instructions below to install the batteries:

- The battery compartment is under the seat
- Lift the seat cover to expose the battery compartment (Figure 4.5.1 detail 1)
- Install the batteries into the battery compartment (Figure 4.5.1 detail 2) and make sure there is no damage to the battery housings
- Ensure all connections and terminals are clean
- Use the handles on the batteries to move them

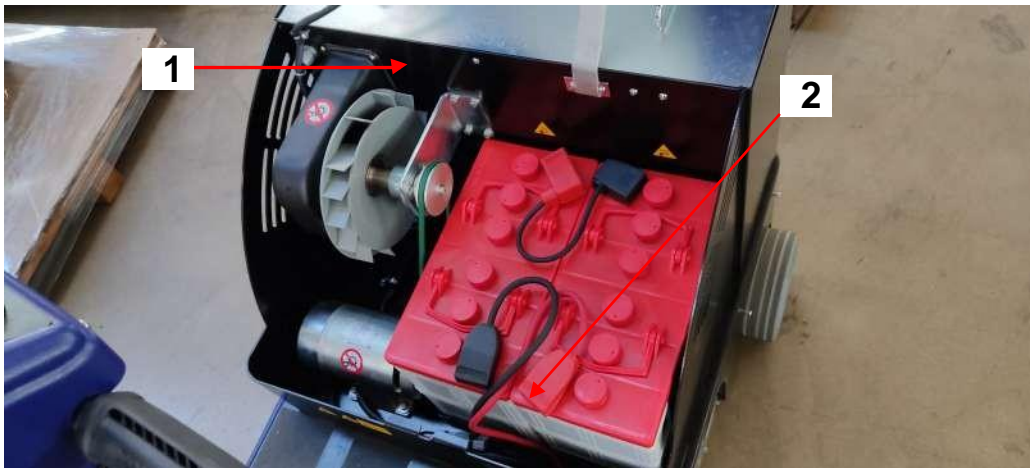

Figure 4.5.1

4.6. CONTROL DEVICES

4.6.1. Control Panel

The control panel controls the main functions of the machine. (Figure 4.6).



Figure 4.6

POS.	IMAGE	FUNCTION
1		<u>SAFETY DIAGNOSTIC</u>
2	ON/OFF	<u>KEY SWITCH</u>
3		<u>FORWARD-REVERSE</u>
4		<u>BATTERY CHARGER INDICATOR</u>
5		<u>FILTER SHAKER</u>
6		<u>HORN</u>

4.7. FUNCTIONS

Turn the key to the on position and lower both the side and the central brushes with the brush control levers (Figure 4.7).

Brushes will start working when forward motion begins. Drive the machine at a consistent speed while sweeping.

Always keep filter clean to ensure proper operation. Use the filter shaker regularly by using the switch on the control panel (Figure 4.6).



Before proceeding with operation, please ensure all guards and protections are installed and functioning properly.

4.7.1 LEVERS & PEDALS

This machine is equipped with following operational levers:

- Accelerator lever located on the right side of the operator control handles. To operate, toggle the Forward / Reverse switch and slowly squeeze the accelerator using the right hand.



The accelerator lever starts the vacuum motor and brushes of the RSW28.

- Side brush control lever (picture 4.7 detail 1): push the lever down and the side brush will lower to the floor.
- Central main brush control lever (picture 4.7 detail 2): push the lever down and the central main brush will lower to the floor.
- Flap pedal lever (picture 4.7 detail 3): press the flap lever with the left foot and bottom flap is raised.



3

2

Figure 4.7

4.7.2 MAIN BRUSH REPLACEMENT

- Remove the key from the ignition key switch.
- Remove the plastic protection guard on the left side of the machine.
- Remove the panel protection in order to reach the main brush.
- Remove the brush support.
- Replace the brush. Follow the instructions in reverse order.



Figure 4.7.2a



Figure 4.7.2b

4.7.3 SIDE BRUSH REPLACEMENT

- Remove the key from the ignition key switch.
- Raise the side brush with the brush control lever as described in section 4.7.1.
- Remove all the screws that secure the side brush from the top of the center hub (picture 4.7.3 detail 1).
- Replace the brush; Follow the instructions in reverse order.

1



Figure 4.7.3

4.7.4 WASTE HOPPER

- Remove the key from the ignition key switch.
- Release the clamp that holds the recovery tank to the machine (picture 4.7.4 detail 1).
- Pull back on the waste hopper tank to separate it from the machine.
- The waste hopper has wheels to easily move to empty it (picture 4.7.4 detail 2).
- Follow the instructions in reverse order to replace the hopper.

1



2



Figure 4.7.4

4.7.5 VACUUM MOTOR MAINTENANCE

Regularly check the operation and efficiency of the vacuum motor.

Accessing the vacuum motor:

- Remove the key from the ignition key switch.
- Lift the seat cover to expose the battery compartment and vacuum motor (figure 4.7.5 detail 1).
- Disconnect the vacuum motor plug (figure 4.7.5 detail 2).
- Remove vacuum motor (figure 4.7.5 detail 3).
- Perform the necessary maintenance.
- Follow the instructions in reverse order to replace the vacuum motor.



Figure 4.7.5

4.7.6 FILTER SHAKER MAINTENANCE

It is important to run the filter shaker to ensure the filter stays clean and the machine is running efficiently.

- Remove the key from the ignition key switch
- Lift the seat cover to expose the battery compartment and filter shaker housing (figure 4.7.6 detail 1)
- Remove the protection panel (figure 4.7.6 detail 2)
- Remove the four knobs (figure 4.7.6 detail 3) and pull the filter shaker motor out
- The filter is now accessible for maintenance
- Follow the instructions in reverse order to complete the filter shaker maintenance

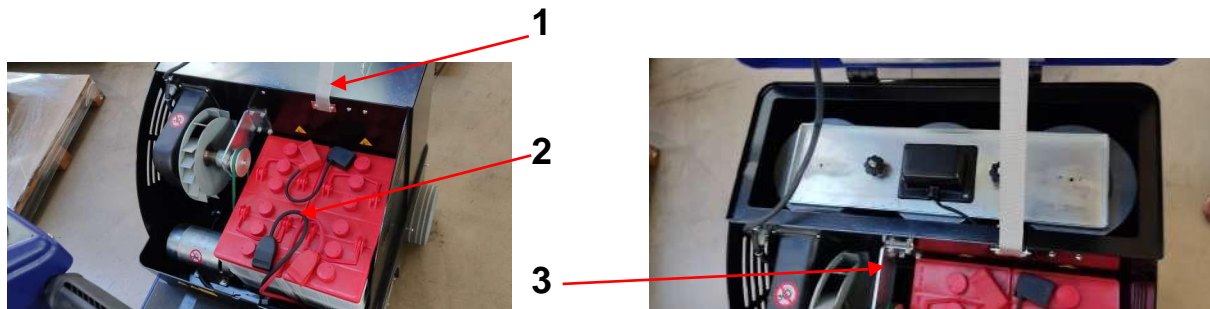



Figure 4.7.6

5. MAINTENANCE

5.1. MAINTENANCE TABLE

It is essential to perform scheduled routine maintenance. Use the table below as a reference.

	<ul style="list-style-type: none"> ➤ <i>Service and maintenance should be performed by authorized personnel only.</i> ➤ <i>For assistance and spare parts contact Pacific Floorcare.</i>
---	--

OPERATION	INTERVENTION	HOW OFTEN
Cleaning	Clean the recovery tank	Daily
	 <ul style="list-style-type: none"> • Do not use corrosive substances 	
	<ul style="list-style-type: none"> ➤ Check the suction hoses 	Weekly
Check up	<ul style="list-style-type: none"> ➤ Check the rubber suction blades of the central brush 	Every 15 days
	<ul style="list-style-type: none"> ➤ Check the battery water level 	Every month
	<ul style="list-style-type: none"> ➤ Check the vacuum motor 	Every 3 months
	<ul style="list-style-type: none"> ➤ Check the breaking system 	Every 6 months
	<ul style="list-style-type: none"> ➤ Check the connection of the battery cables 	Every year
	<ul style="list-style-type: none"> ➤ Check the brushes of each motor 	Every year
	<ul style="list-style-type: none"> ➤ Check the safety devices ➤ Check the electric system 	Every year

5.2 BATTERY MAINTENANCE

The battery meter on the control panel will inform the operator of the current status of the battery:

- Green light: Battery level near 100%
- Yellow light: Battery level near 50%
- Red light: Battery level low

	<p><i>The operator must keep the battery compartment open during the battery recharge cycle.</i></p> <ul style="list-style-type: none"> ➤ <i>Do not use flames and/or smoke near the batteries</i> ➤ <i>Use extreme caution so there no exposure to battery acid</i> ➤ <i>Keep sparks away from the batteries</i> ➤ <i>Do not invert / reverse battery polarities.</i>
---	--

5.2.1 BATTERY WATER LEVELS

In order to check the batteries water levels follow the steps below:

- By means of a hydrometer draw a small quantity of electrolyte so that the floater reaches the surface
- Make sure that the float inside the hydrometer is not blocked
- Before taking a new measurement, fill the batteries with distilled water (section 5.2.2) and wait until the water levels become uniform in the cells.

5.2.2 FILLING BATTERIES

- Using only distilled water, fill each battery cell before the recharging. The water inside the batteries must be 1/4" or 6 mm over the plates
- Repeat this operation every time the levels decrease. Check weekly.

5.2.3 CHARGING

It is not necessary to recharge the batteries if the hydrometry, after a work day, is not under 1.24 (28 Bè). Ideal temperatures should not exceed 113°F or 45°C. If the electrolyte temperature increases more than 50/54°F or 10/12°C relative to the outside temperature, the batteries can be overcharged.

5.2.4 INACTIVE BATTERIES

Inactive batteries will lose their charge automatically over time. If batteries will be idle for a period of time, perform the following:

- Charge the batteries once a month with a 'final' stream intensity until gas is spread and the batteries voltage and weight are constant for 3-4 hours. This operation has to be done even if the absolute weight is high;
- Keep the batteries in a dry place away from potential hazards.

5.2.5 DISPOSAL

Recycle or dispose of batteries in accordance to local and federal laws.

5.3 CHECKING THE ELECTRICAL SYSTEM

The electrical system must be checked every two years. Immediately replace any defecting, worn or damaged components.

Do not continue to use the machine unit the repairs are completed by authorized personnel.



All maintenance and repairs must be done by authorized personnel.

5.4 TESTING SCHEDULE

Check	Frequency	Performed by
Safety devices	2 years	Trained technician
Electric system	2 years	Trained technician
Braking system	3 months	Trained technician
Check up	5 years	Trained technician
Recovery tank	Daily	Operator
Vacuum filter	Daily	Operator
Suction hoses	Weekly	Operator
Batteries water level	Weekly	Operator
Batteries cables	6 months	Trained technician
Motor brushes	Every year	Trained technician

5.5 MAINTENANCE LOG

<i>DATE</i>	<i>NAME</i>	<i>NOTES</i>	<i>INITIALS</i>

Serial no.

Date of installation
